

TOWNS

LES

MENES

HÉ. EST-CE QUE BOIRE DE L'ALCOOL AVEC UNE AMIE, JUSTE TOUS LES DEUX DANS UNE PIÈCE, TE SEMBLE OK ?



HUM, ET ALORS ?

C'EST PAS BIZARRE, SI ?

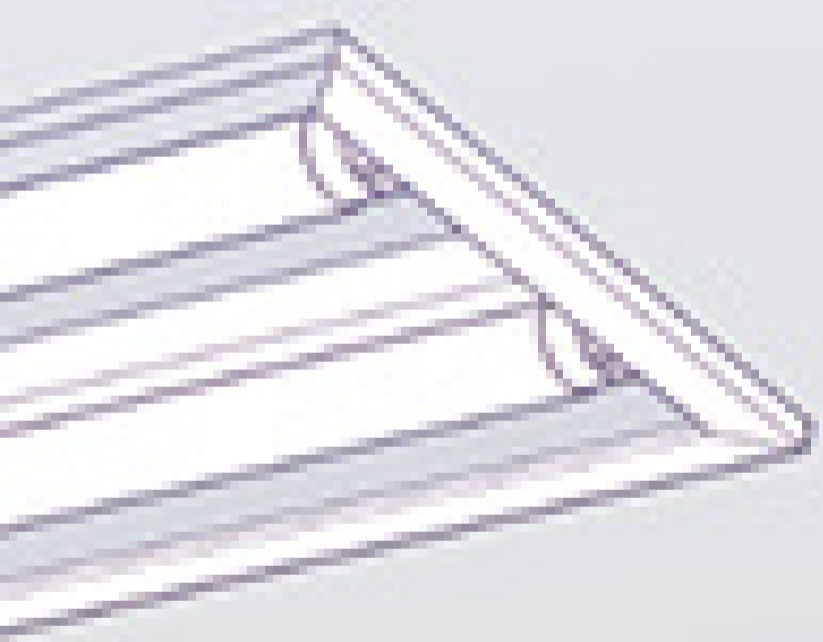





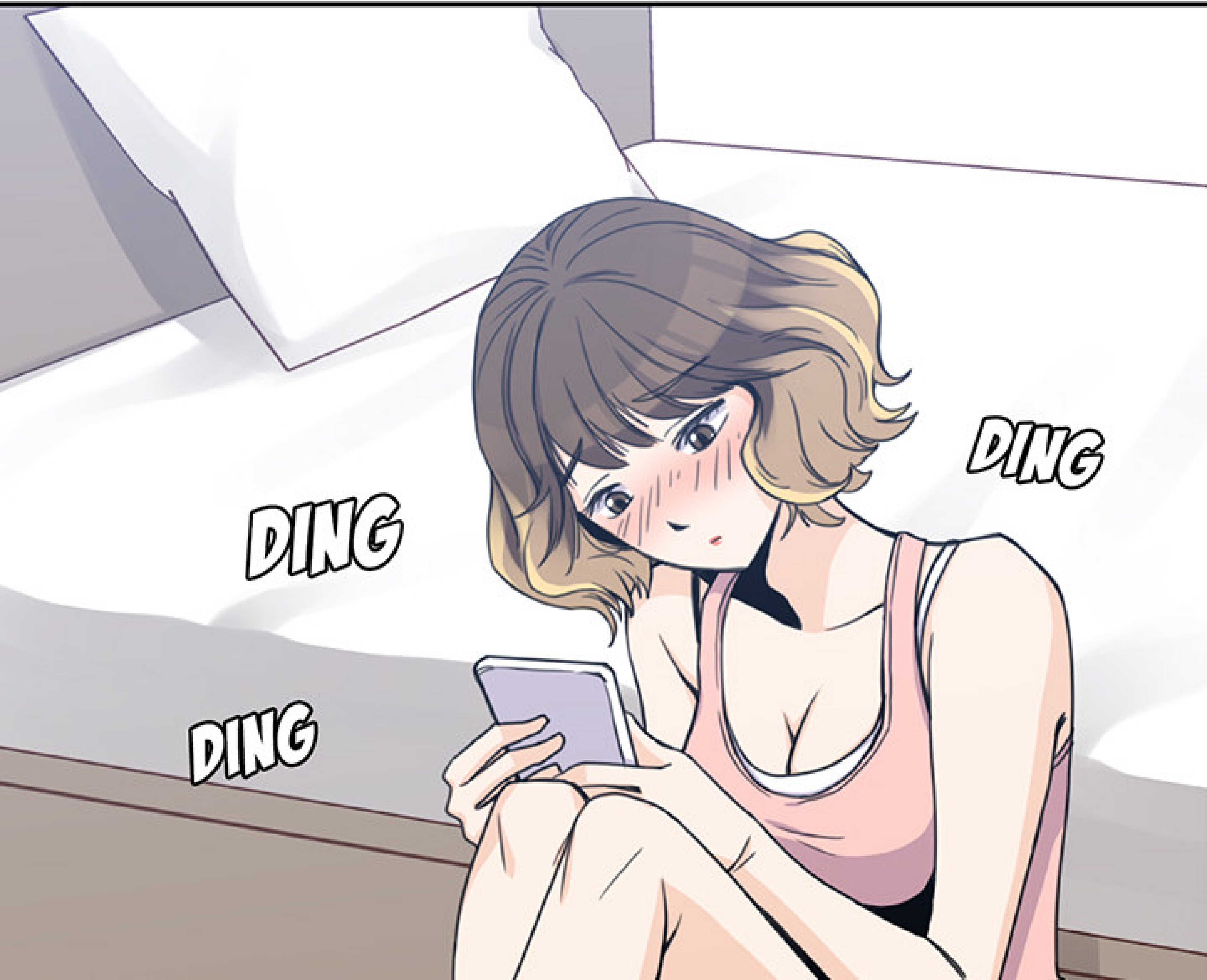

***DING***

***DING***

***DING***



A comic panel with a light blue background. In the foreground, a man with dark blue hair and a white t-shirt is talking on a black mobile phone. He has a slightly annoyed or impatient expression. In the background, a woman with brown hair is looking down at her phone. Two speech bubbles are present: one from the man and one from the woman.

IL EST SUPER TARD,  
POURQUOI TU ME  
DÉRANGES ?

LA FERME.  
JIMMY, TU NE  
VIENS PAS  
ALORS ?





MON AMIE  
VEUT TE RENCONTRER.  
ALLEZ, FRÈRE.



MON AMIE  
EST SUPER SEXY,  
JE TE JURE.  
HAHAHA.

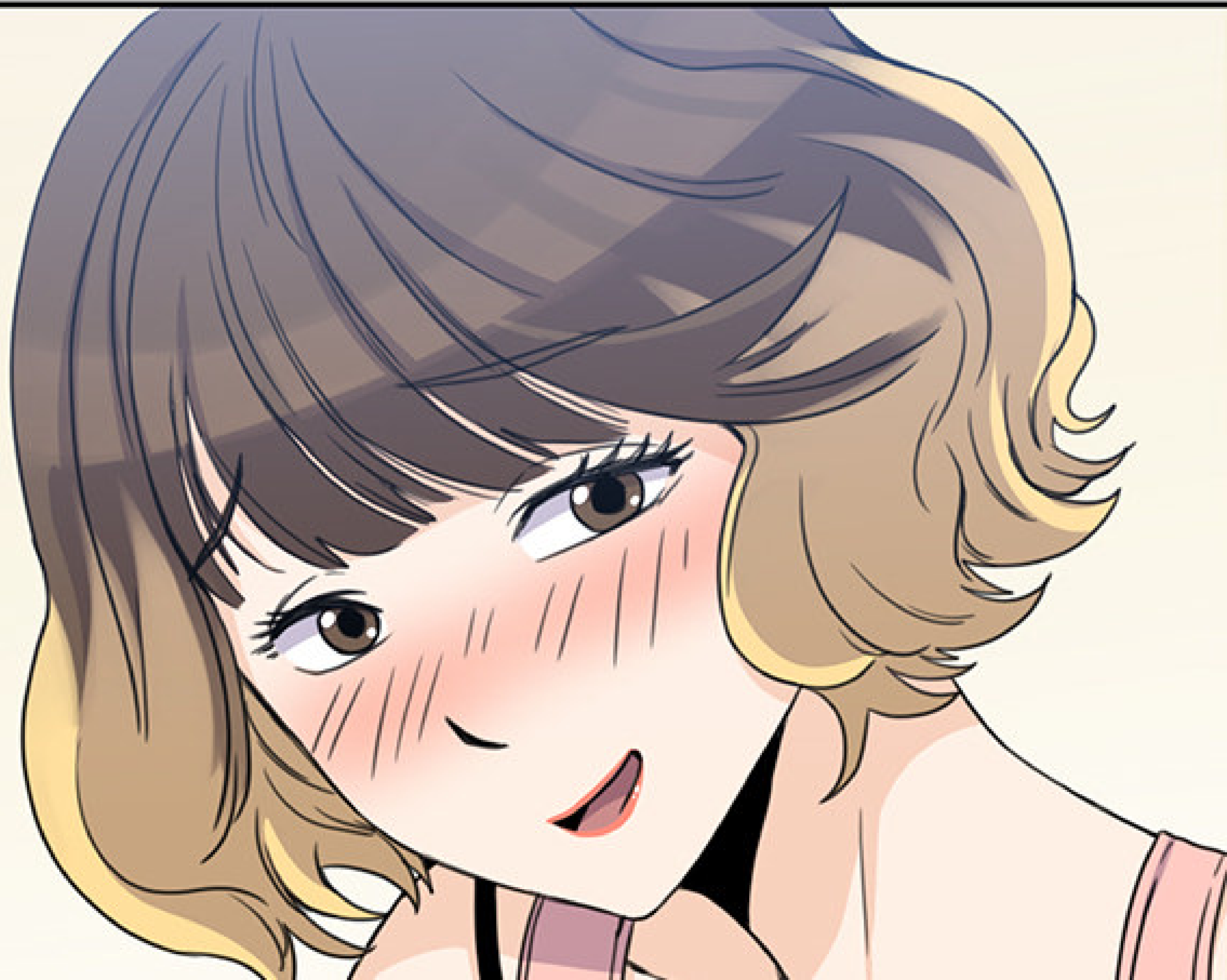

A close-up illustration of a woman's face, showing her eyes and mouth. She has a surprised or questioning expression. A speech bubble is positioned to the left of her face.

QUOI...?

A partial illustration of a person's head, showing dark hair. A speech bubble is positioned above the head.

OK, D'ACCORD.  
JE VAIS VENIR.



MAIS SI UNE FILLE BOIT  
JUSQU'À CE QU'ELLE SOIT  
SOÛLE, ÇA VEUT DIRE  
QU'ELLE EST INTÉRESSÉE  
PAR LE TYPE, NON ?



PROBABLEMENT ?

POURQUOI SE SOÛLERAIT-ELLE  
CHEZ UN AMI MASCULIN SINON ?  
ÇA VEUT FORCÉMENT DIRE QUELQUE

ÇA VEUT FORCEMENT DIRE QUELQUE  
CHOSE... LOL

MERDE...  
IL FAIT FROID...  
J'AURAIS DÛ PRENDRE  
UNE VESTE.





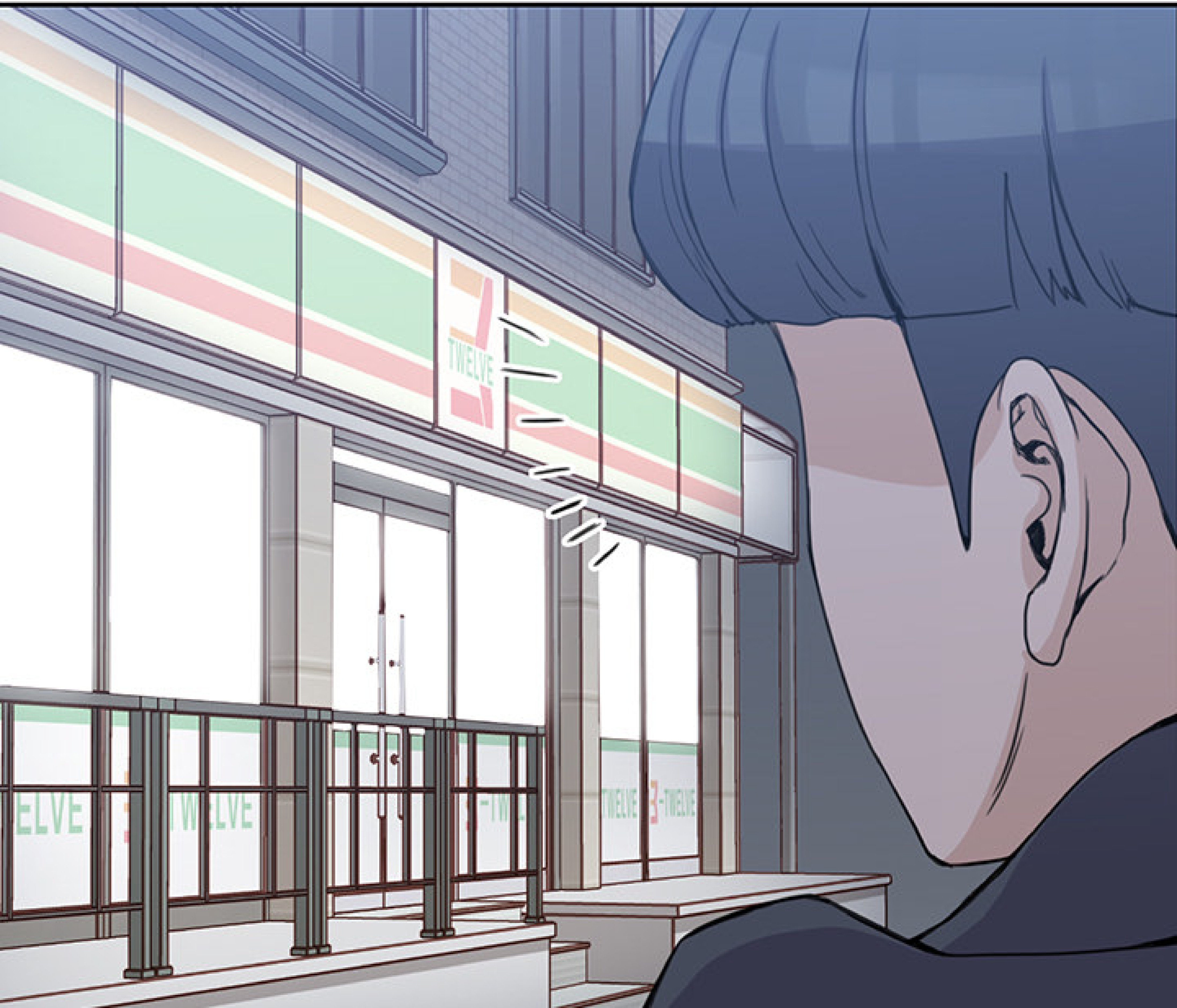



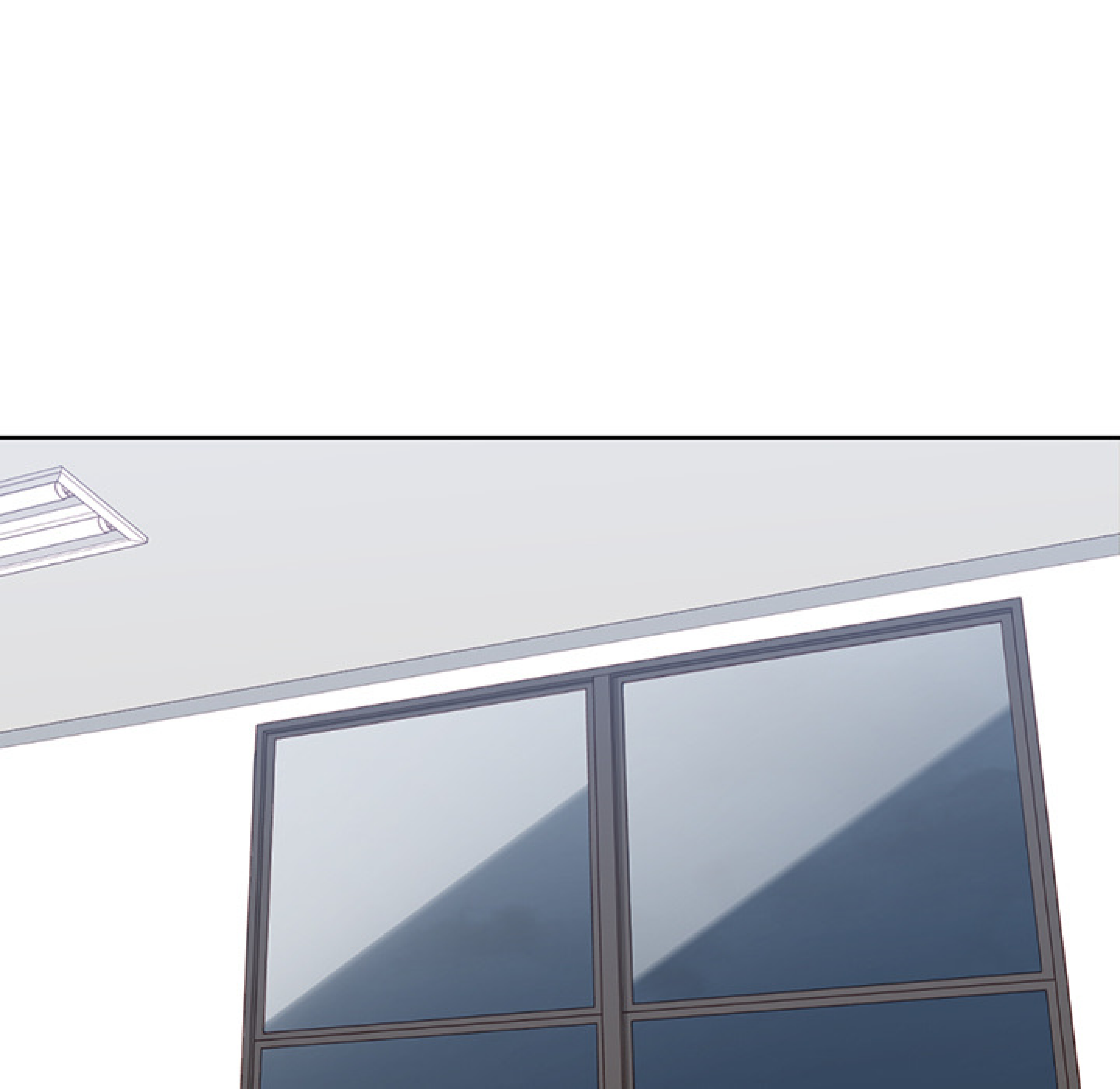



AH... IL FAUT QUE  
JE PARTE TOUT DE  
SUITE...





MON AMI VA ARRIVER.  
DIS-LUI BONJOUR AU  
MOINS.



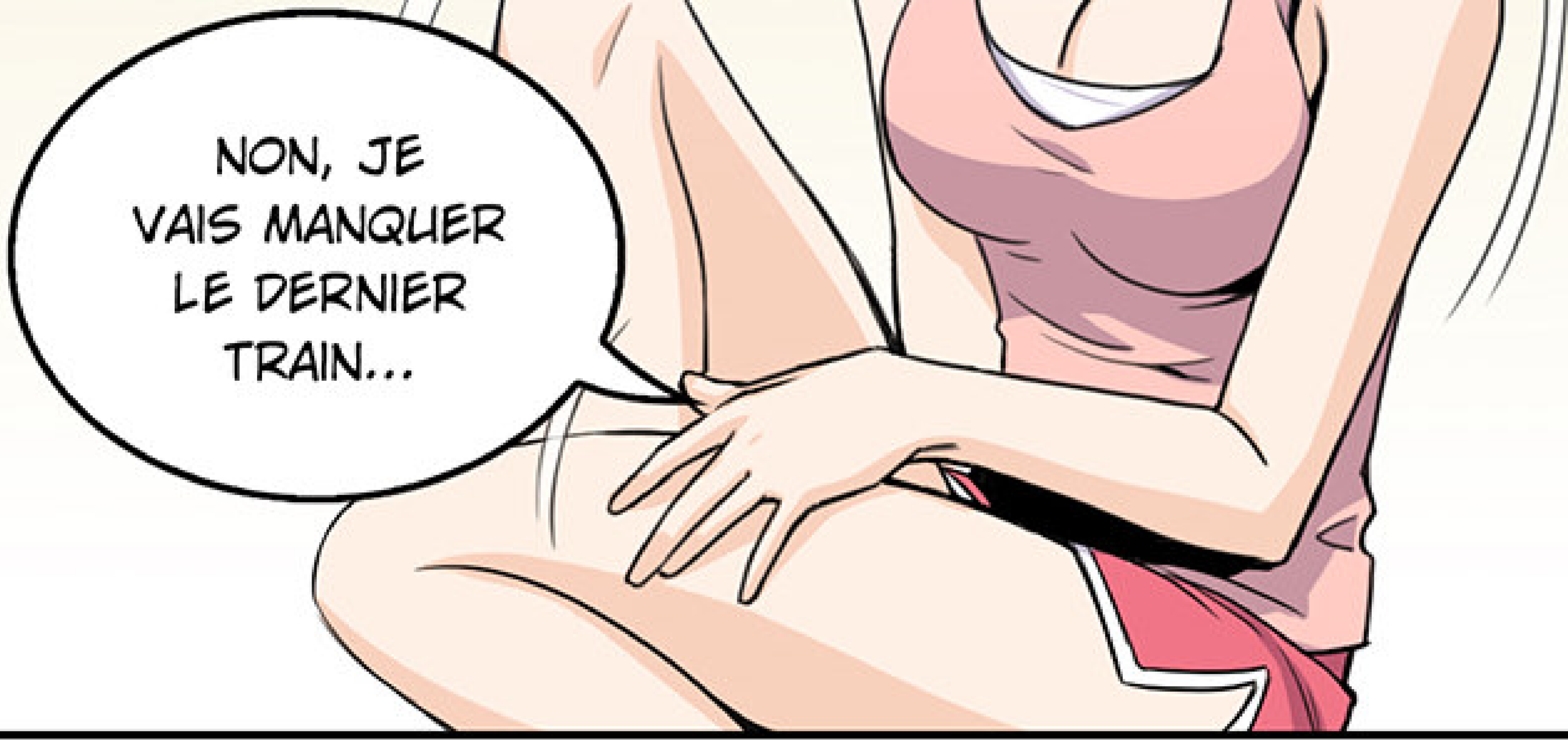



JE LUI AI DEMANDÉ  
DE PRENDRE PLUS DE  
BOUTEILLES EN CHEMIN.  
TU NE PEUX PAS PARTIR  
MAINTENANT.

CE N'EST PAS BIZARRE ?  
SE SAOULER CHEZ UN  
TYPE AVEC LEQUEL

ET AVEC LEQUEL  
TU NE SORS PAS ?



PEU IMPORTE TANT QU'ELLE  
NE SORT PAS AVEC MOI.





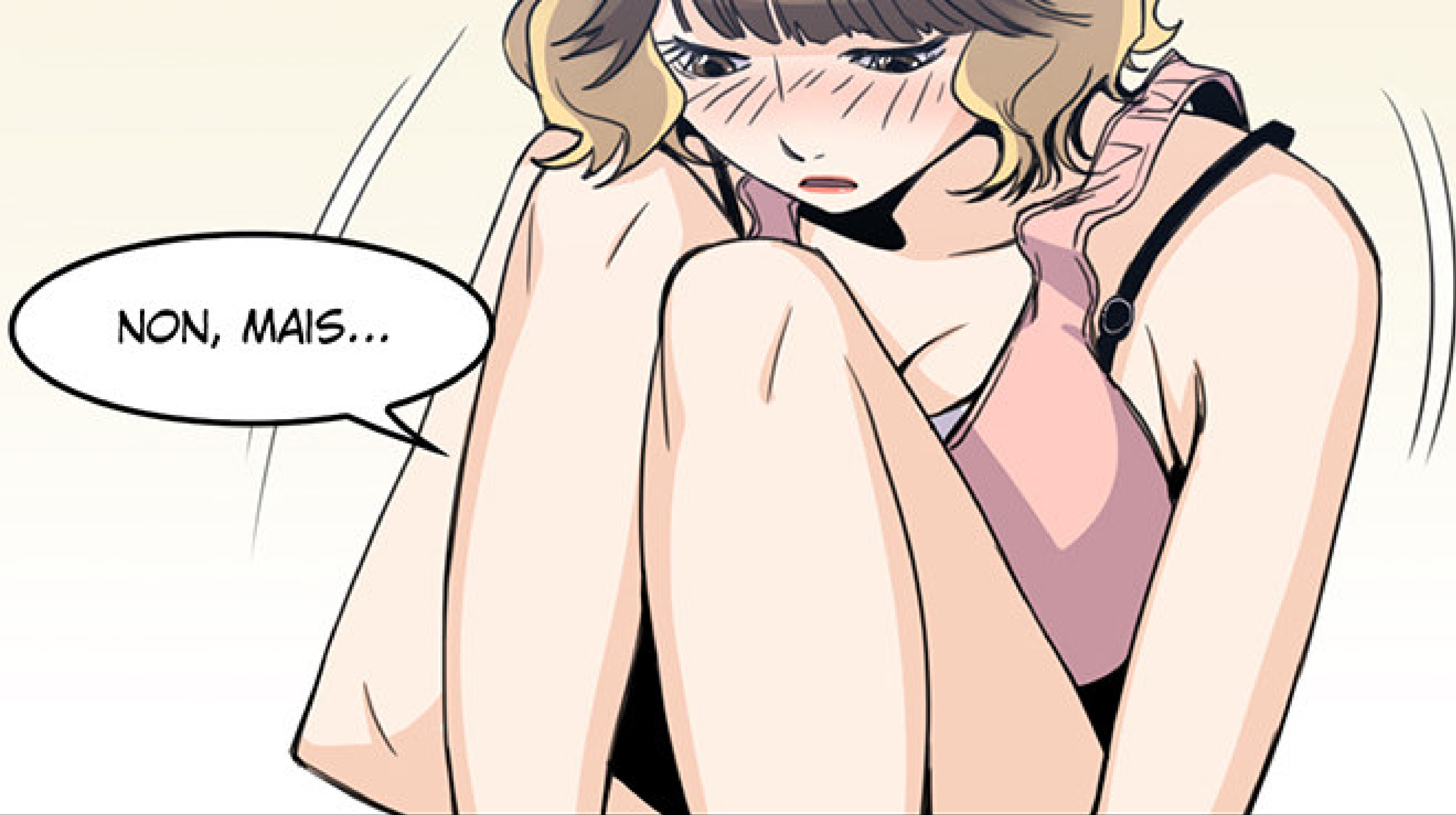



TOC

TOC

TOC

OH !  
IL EST  
LÀ !

C'EST  
OUVERT.  
ENTRE !

IL FAIT  
SI FROID  
DEHORS.









DIS BONJOUR  
À MON AMI JIMMY.  
C'EST UN TYPE SUPER  
COOL.



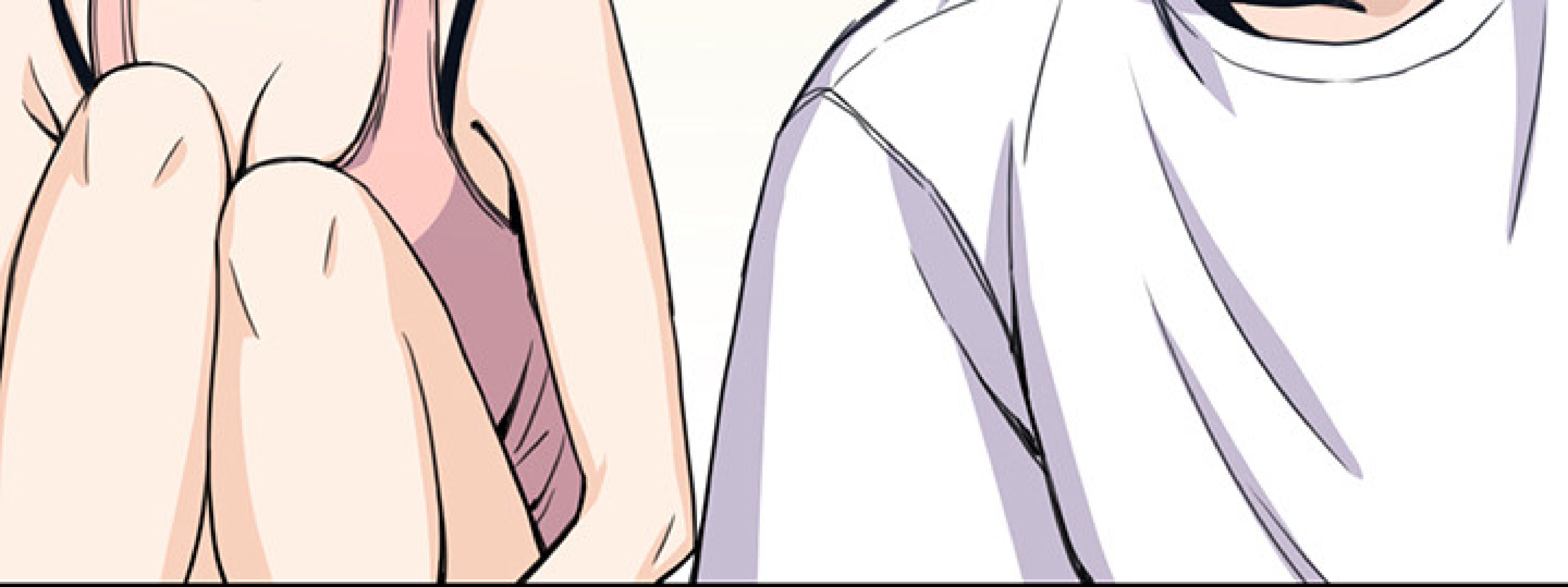

**BON, FRANQUEMENT... JE N'AIME  
PAS CE GENRE DE FILLES.**



SALUT...





HÉ, ASSIEDS-TOI.  
ON EST ENTRE AMIS  
ICI, ALORS PAS BESOIN  
D'ÊTRE COINCÉ AVEC  
ELLE, HAHA.



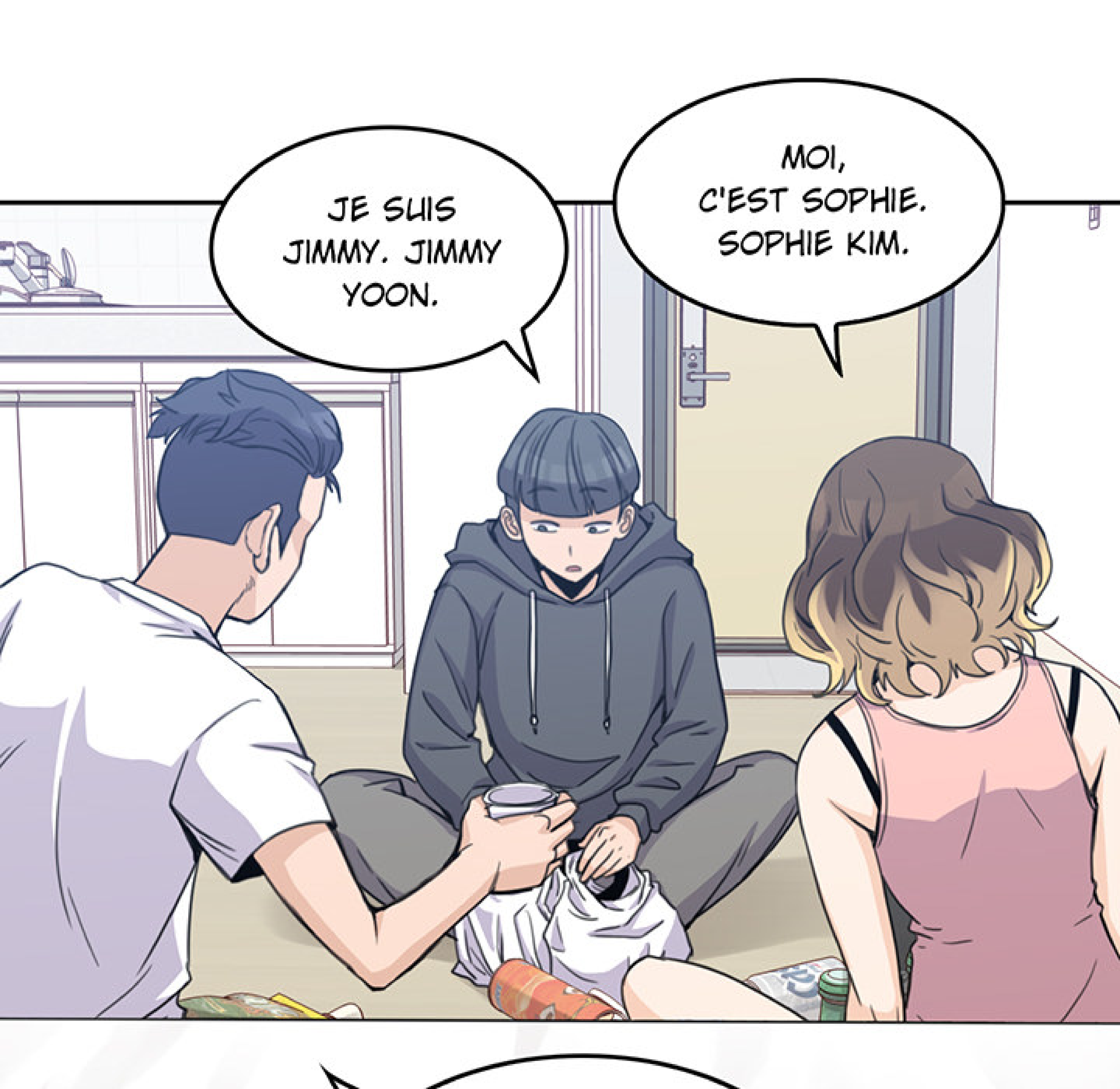

JE SUIS  
JIMMY. JIMMY  
YOON.

MOI,  
C'EST SOPHIE.  
SOPHIE KIM.

OUAIS, OUAIS.  
ÇA SUFFIT POUR LES  
PRÉSENTATIONS.  
BLIVONS !

SANTÉ !



MÊME SI C'EST UN AMI, ÇA RESTE  
UN MEC. ÇA FAIT ALLUMEUSE SI  
ELLE RESTE BOIRE APRÈS LE  
DERNIER TRAIN.



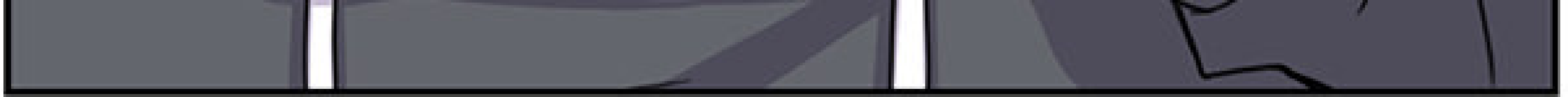

SOPHIE, TU N'AS PLUS  
ASSEZ DE SOJU ! JE VAIS  
TE RESSERVIR UN VERRE.

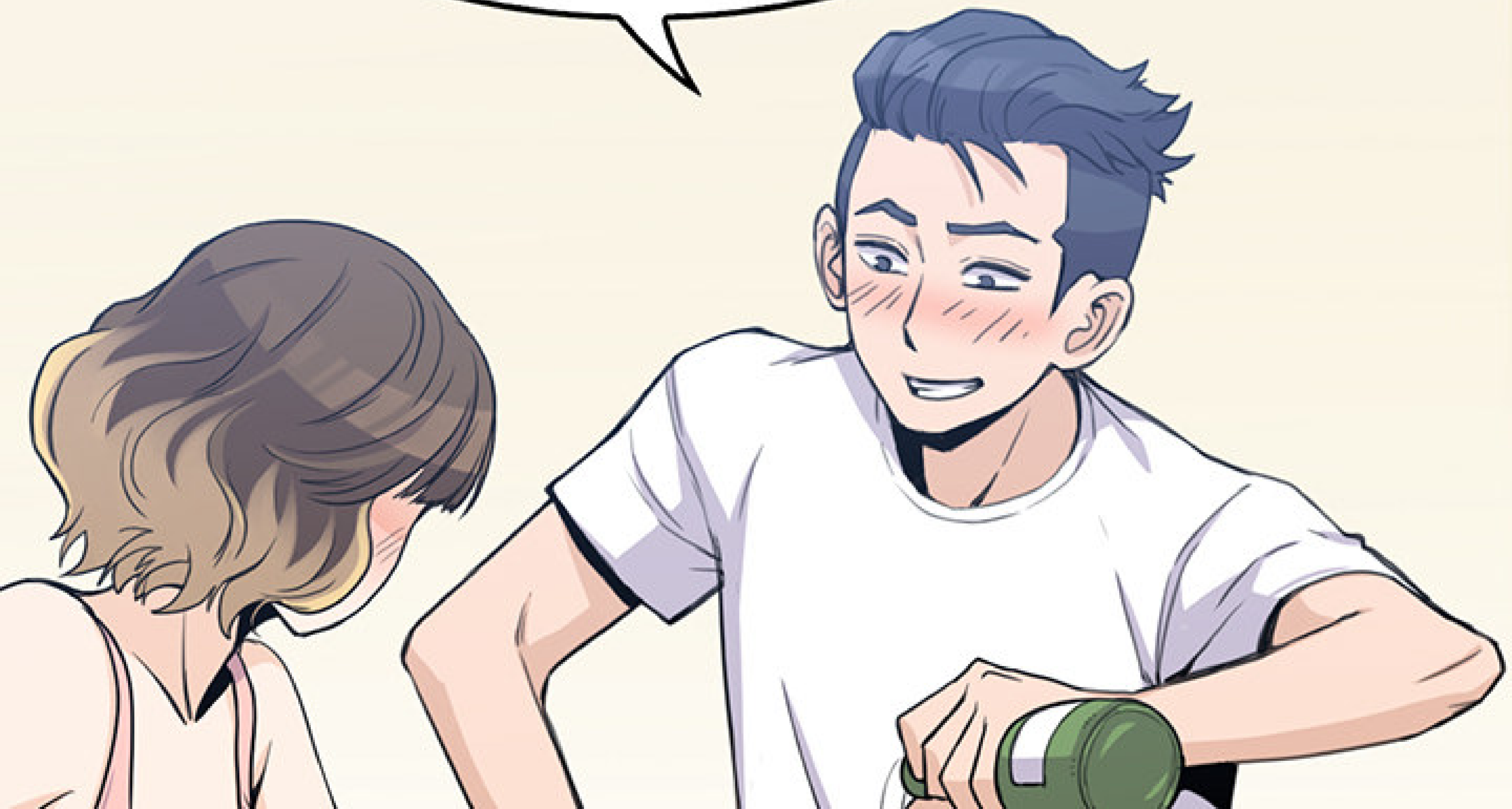





AH, NON... C'EST  
TROP ! JE VAIS ÊTRE  
SOÛLE.

ALLEZ, T'ES  
UNE DURE, TOI !  
C'EST RIEN POUR  
TOI.





AH,  
ÇA SUFFIT !  
ASSEZ !



C'EST PAS DU TOUT CUIT, HEIN ?  
POURQUOI UNE FILLE NORMALE  
FERAIT ÇA SINON ?

**BEUH**



AH,  
C'EST AMER !  
C'EST PAS UN COCKTAIL  
DE SOJU, MAIS JUSTE  
DU SOJU !



CLIC

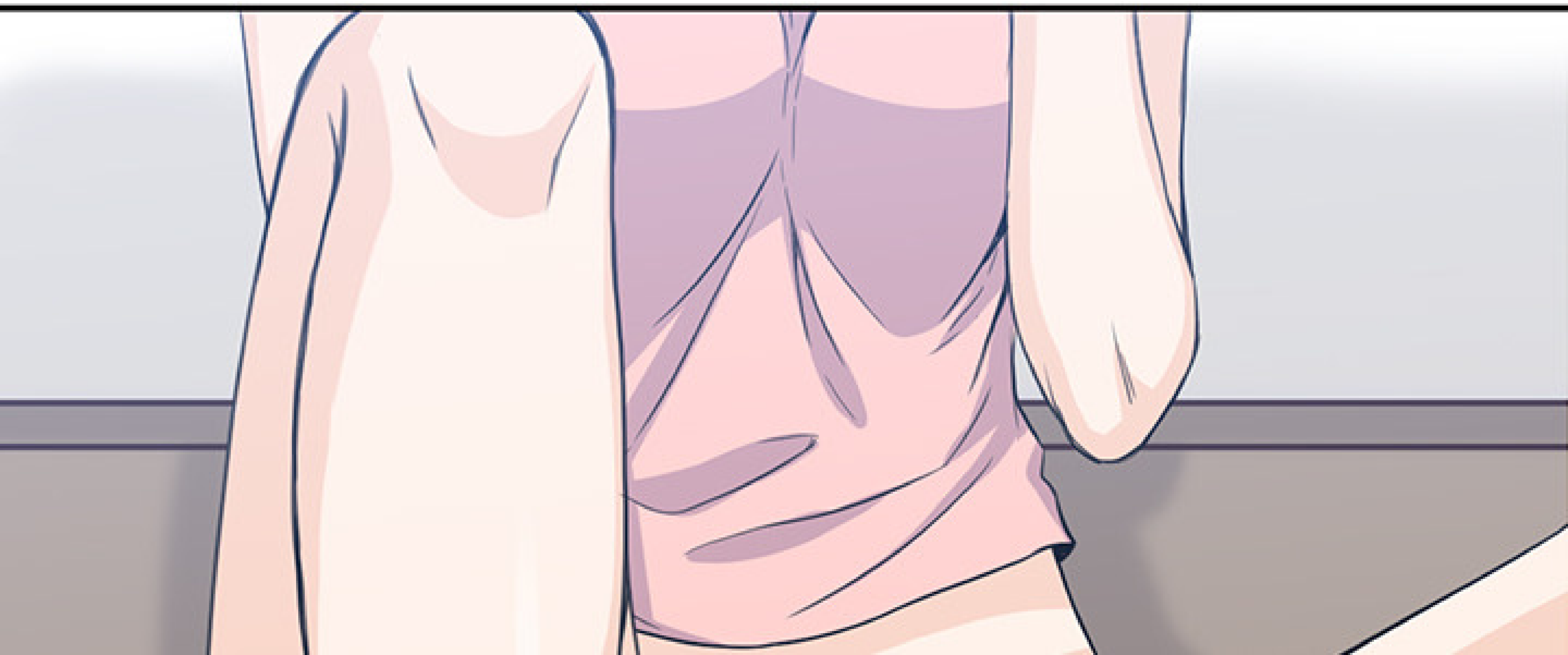

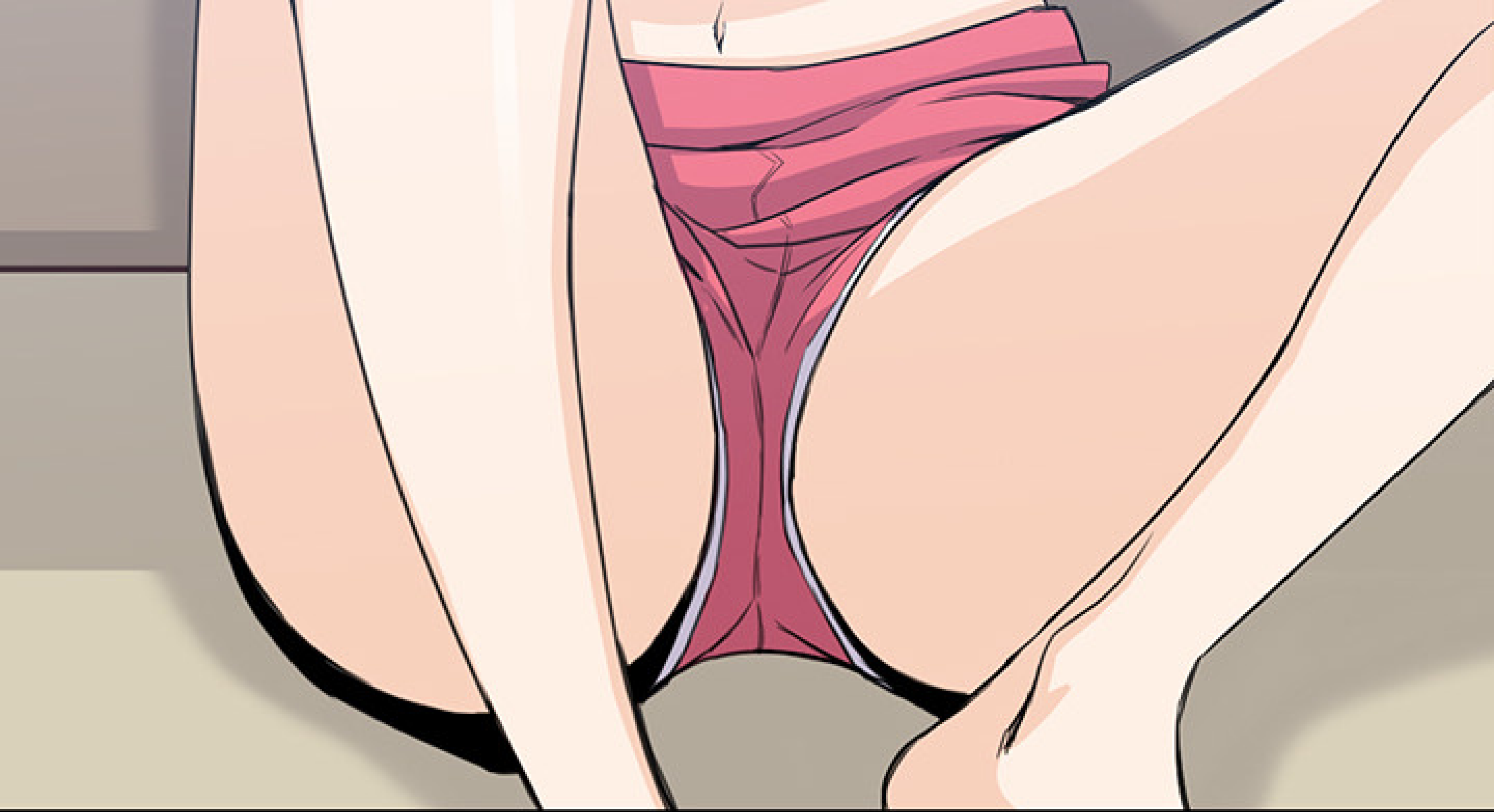

HAHA, HÉ SOPHIE.  
IL EST PAS MIGNON,  
MON COPAIN ?

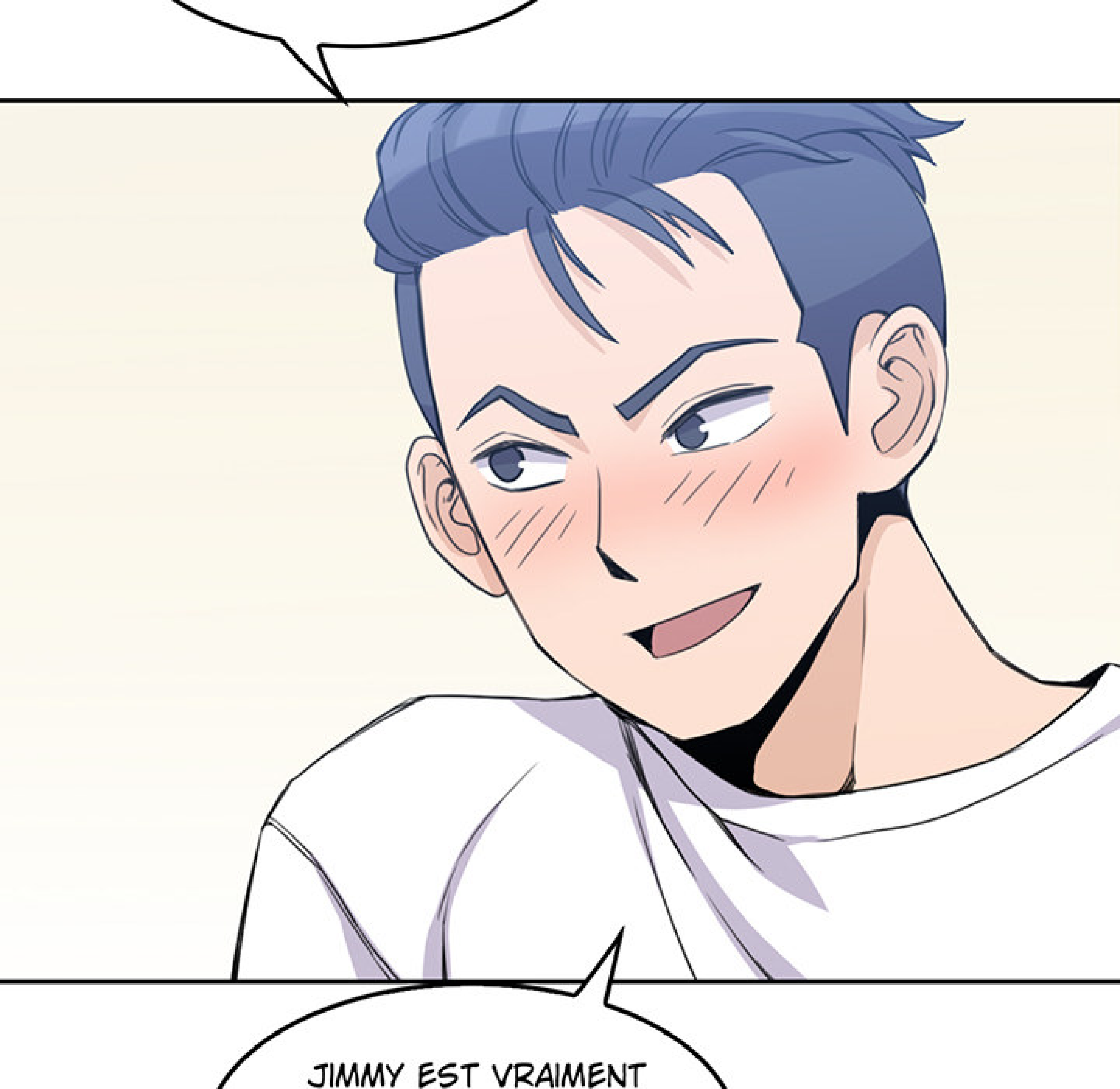

JIMMY EST VRAIMENT



UN TYPE SUPER. NE  
SOYEZ PAS TIMIDES !  
HAHA.

LA  
FERME, CONNARD.  
QU'EST-CE QUE TU  
RACONTES...





**FRISH**

**FRISH**

JIMMY, TU ES SI MIGNON ! HÉHÉ.



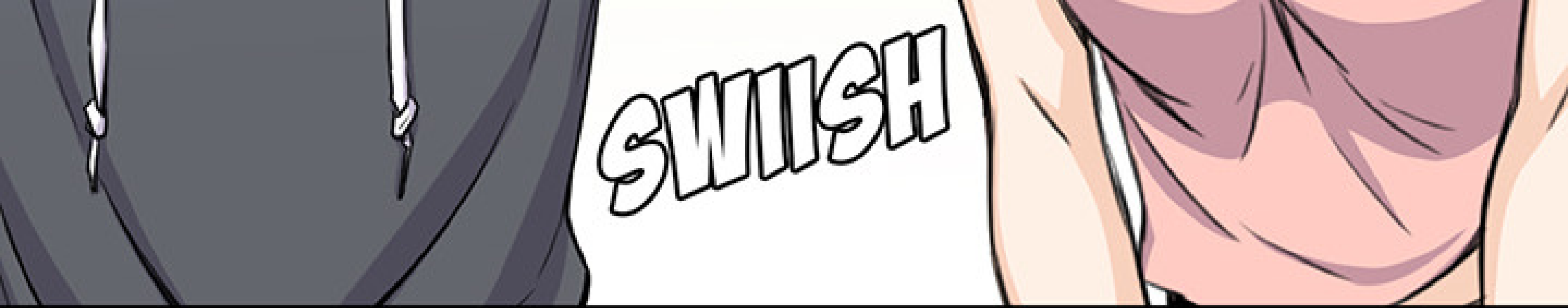

UN COUP D'UN SOIR, C'EST UNE CHOSE,  
MAIS CE GENRE DE FILLES EST UN PEU  
VULGAIRE, NON ? TU SORTIRAIS AVEC  
UNE FILLE PAREILLE, TOI ?

T'ES FOU ? MÊME PAS  
POUR UNE NUIT.

ÇA SERAIT JUSTE CHIANT  
SI ELLE ARRÊTAIT PAS DE  
ME CONTACTER APRÈS...

J'AI ENVIE DE FLUMER...



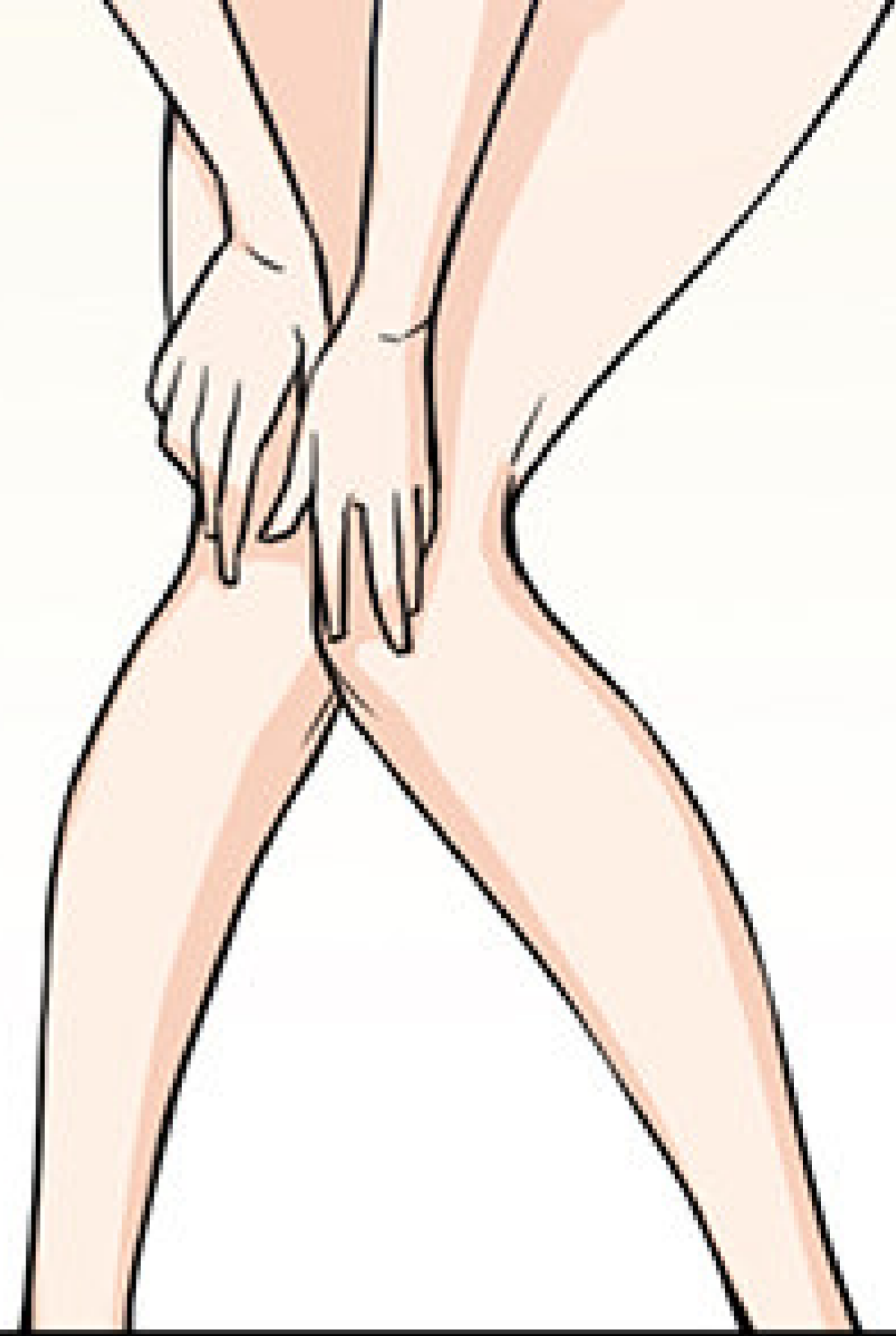

OH, MOI AUSSI...



ON PEUT PAS JUSTE FUMER À L'INTÉRIEUR...?





AH, DÉSOLÉ...  
MAIS MON PROPRIO M'A  
VRAIMENT EMMERDÉ  
AVEC ÇA, DONC...

ALLONS-Y, JIMMY.

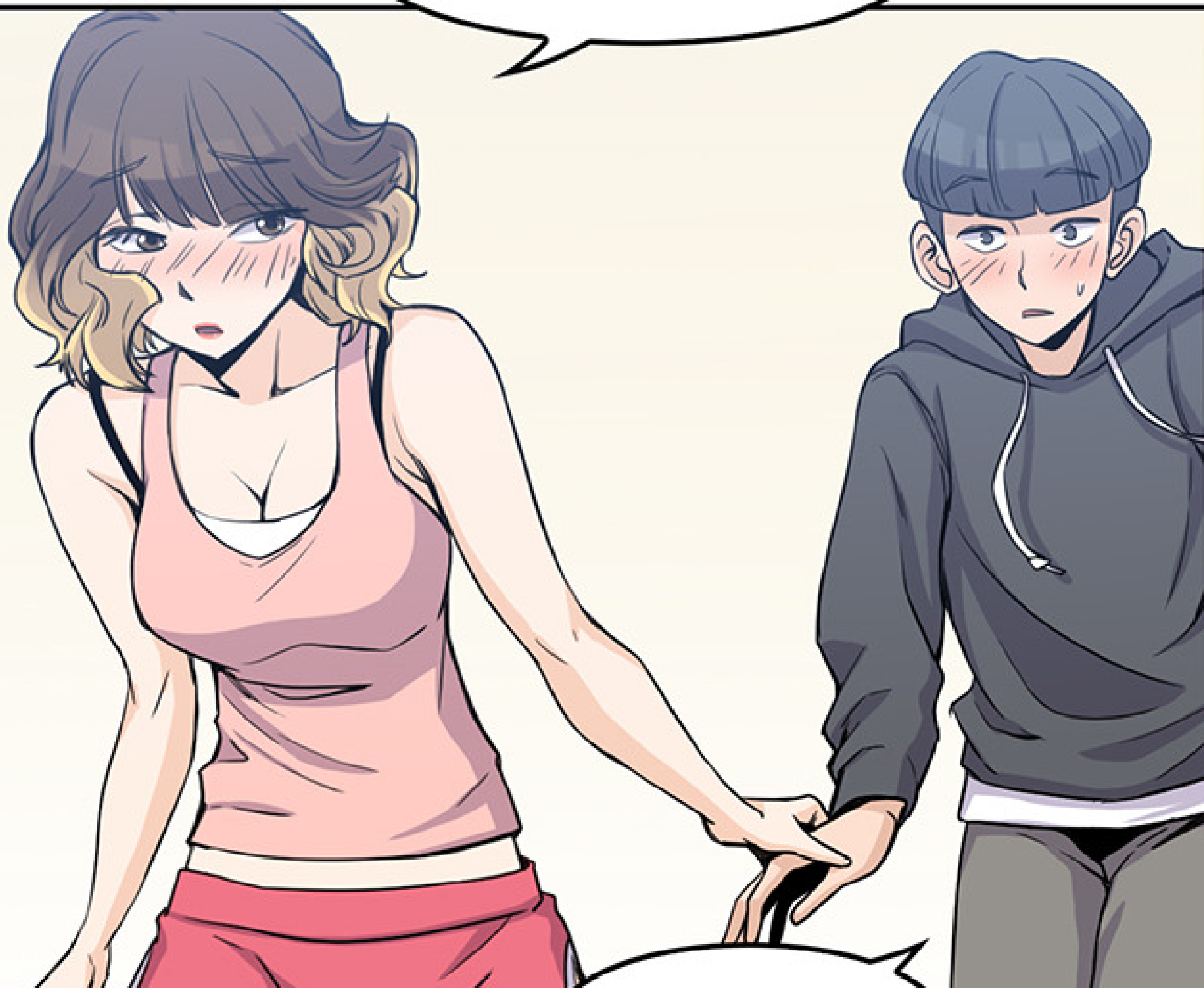



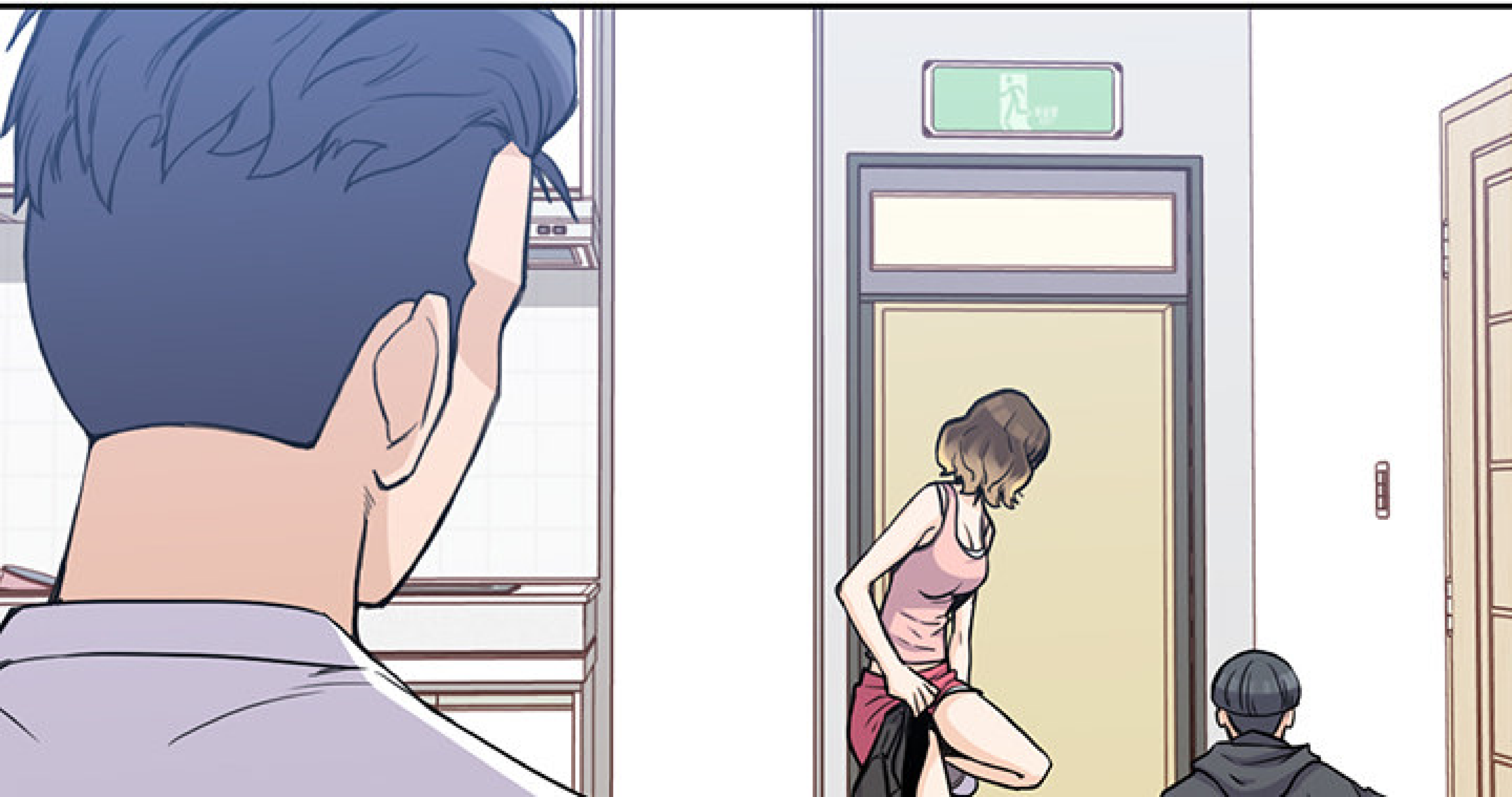





AÏE... MA TÊTE...

ÇA VA ?

NOON  
SNIKE TWS

HEIN ? OUAIS...



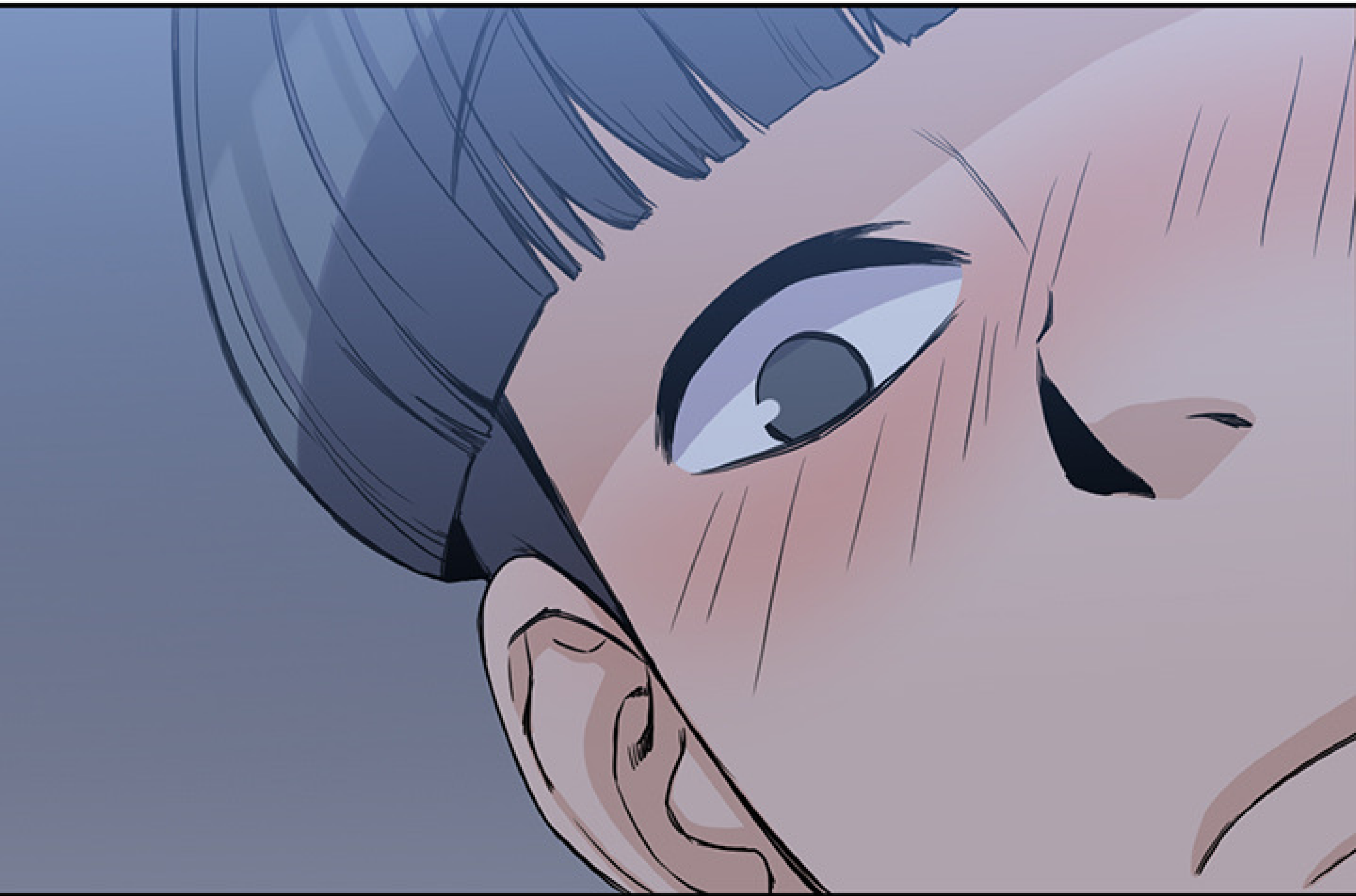

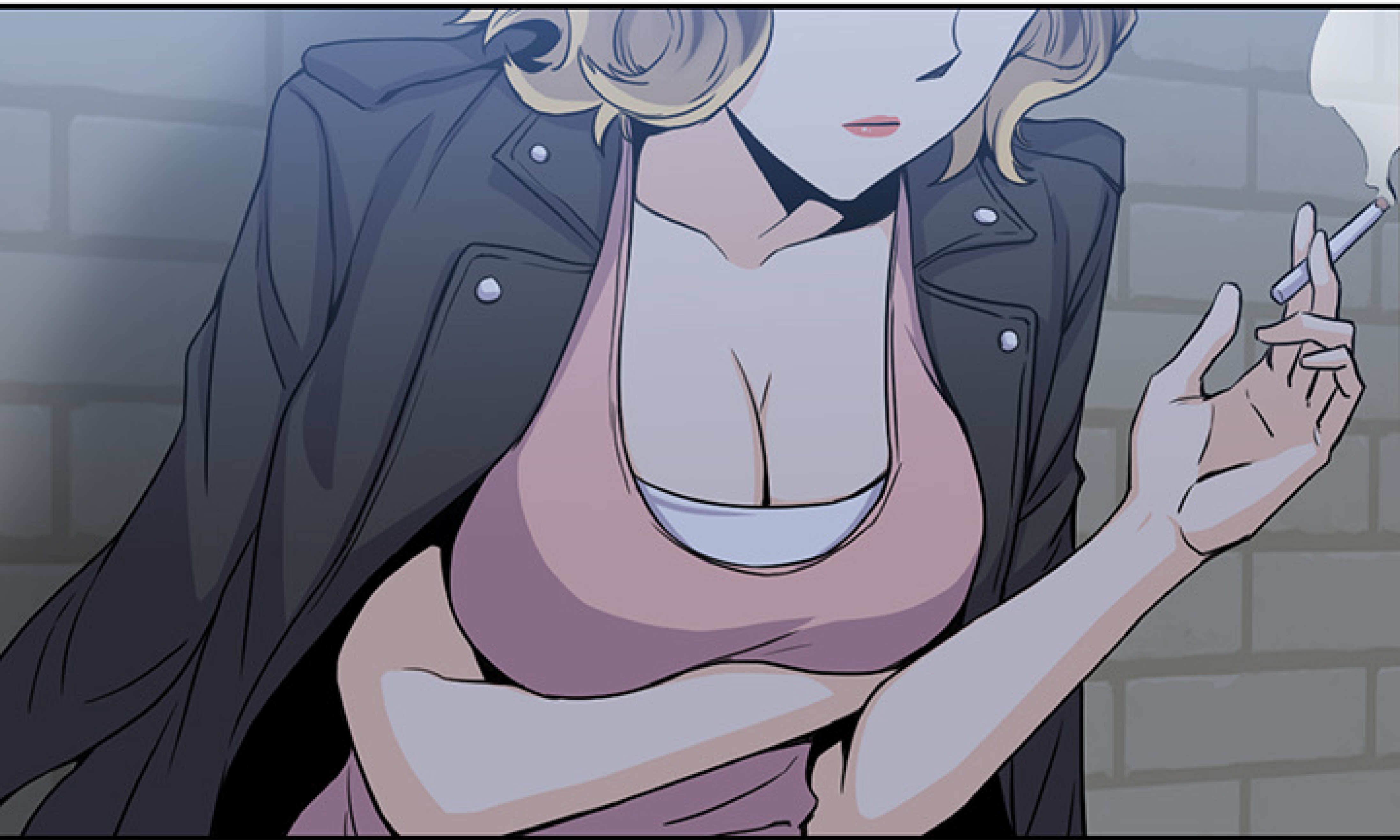







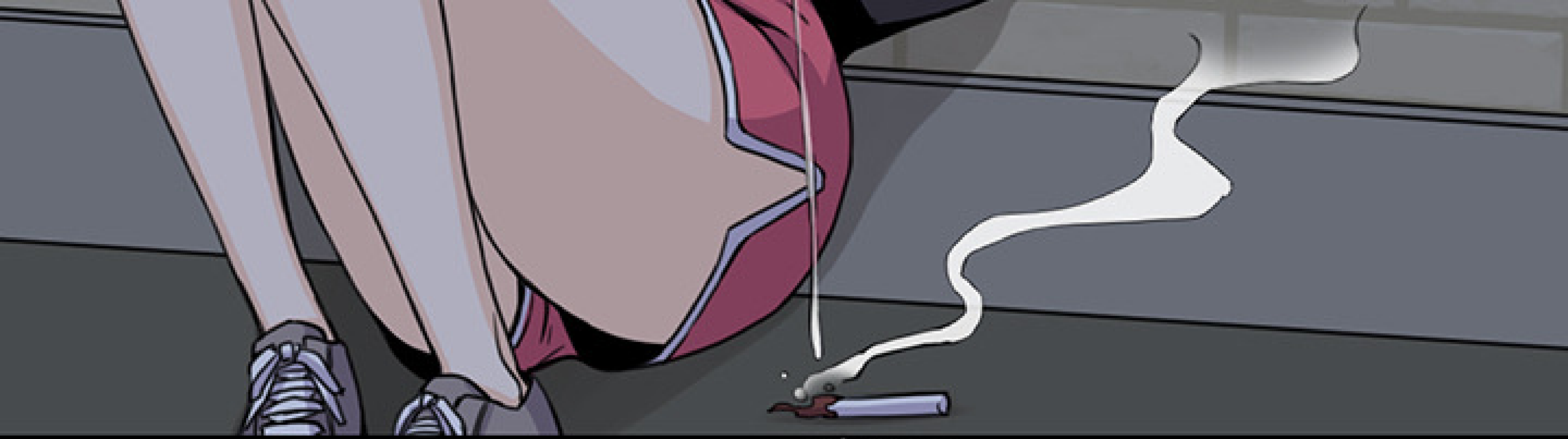

**SZZZ**







ALLONS-Y.

**SWIISH**

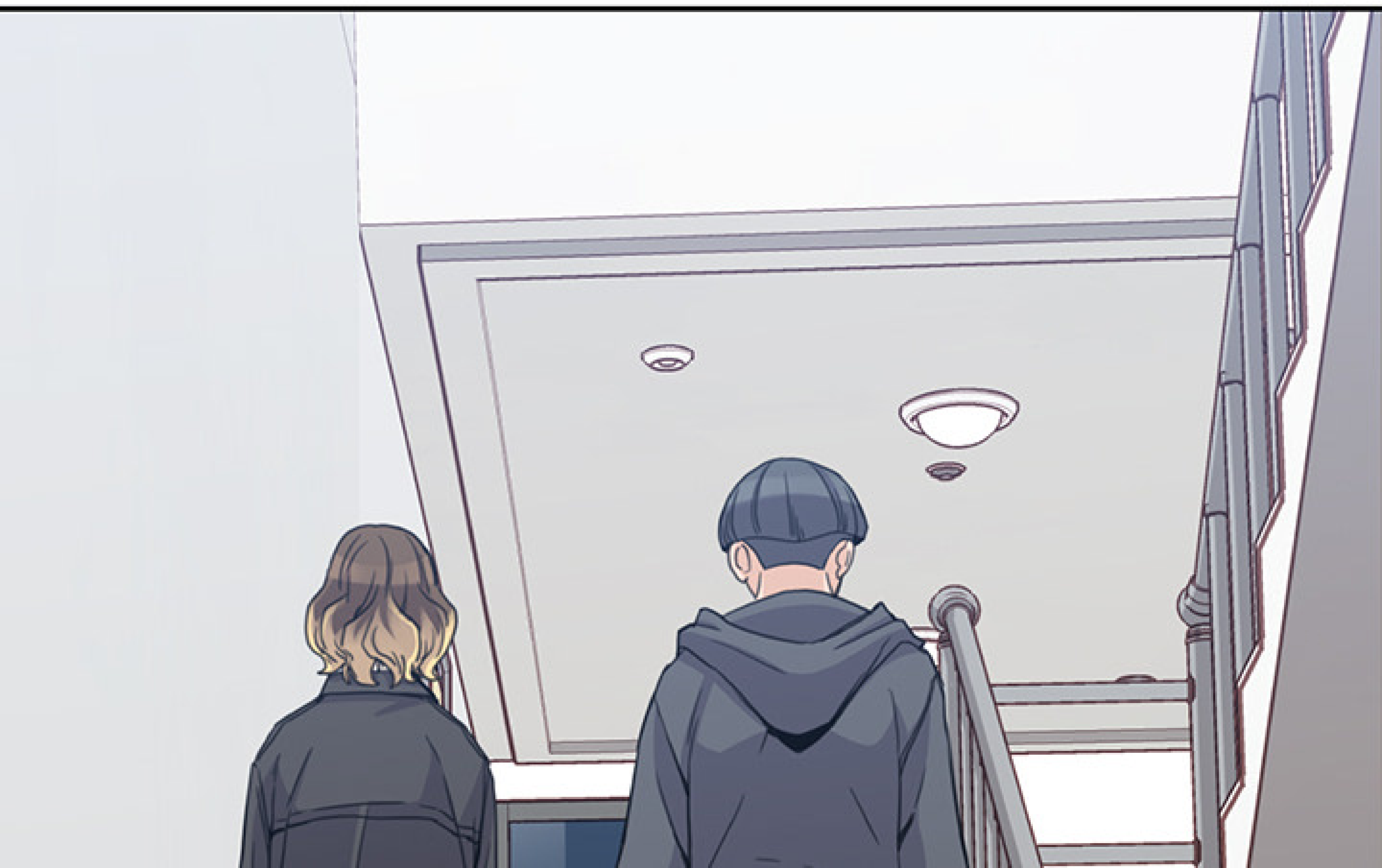

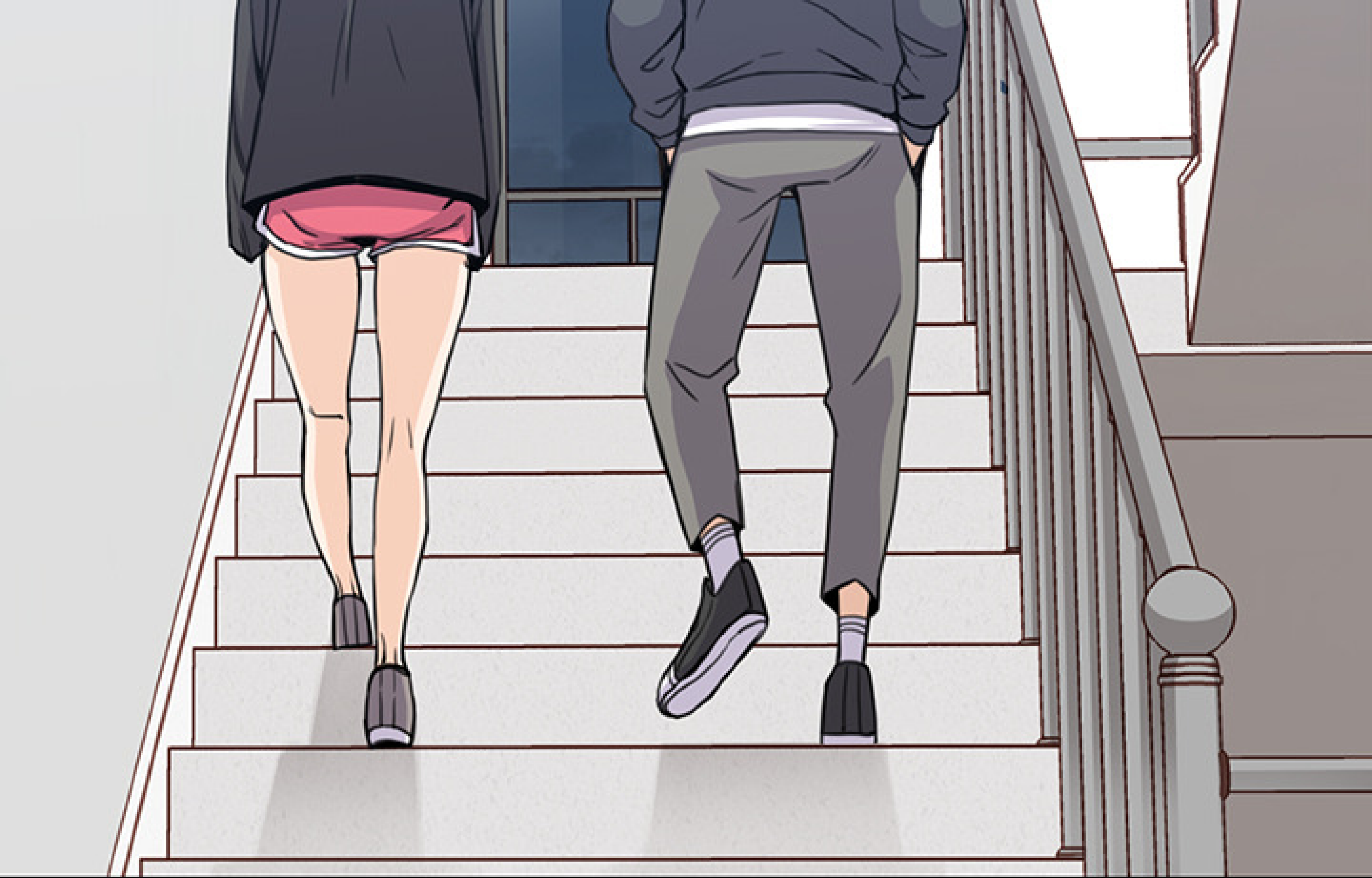

AH, MA TÊTE...

**SWIIP**



**SWIIP**







SWEEP

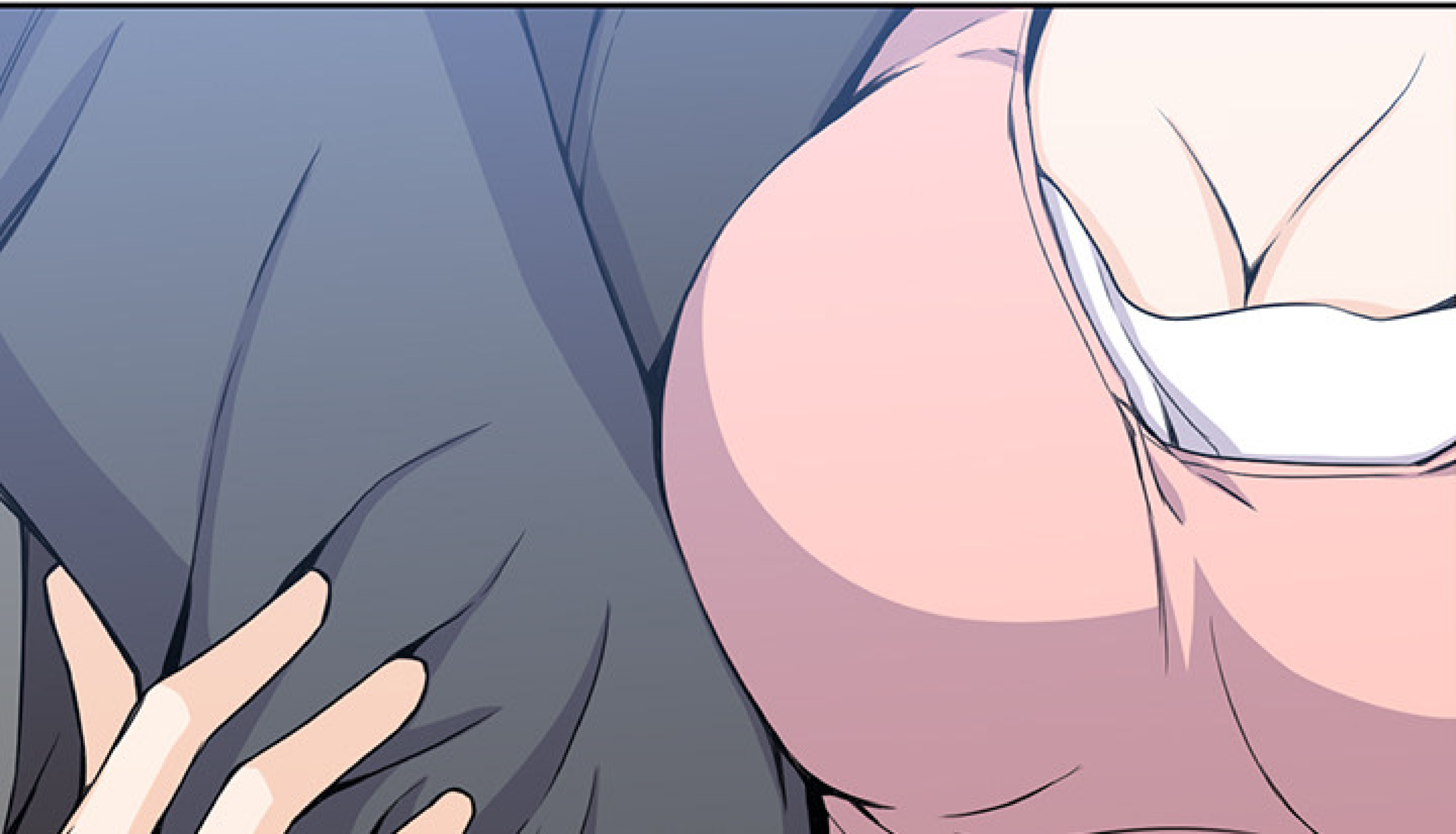

J'AI... LE  
VERTIGE...







**GLOUPS**



HÉ,  
VOUS FAITES QUOI ?  
DÉPÊCHEZ-VOUS !

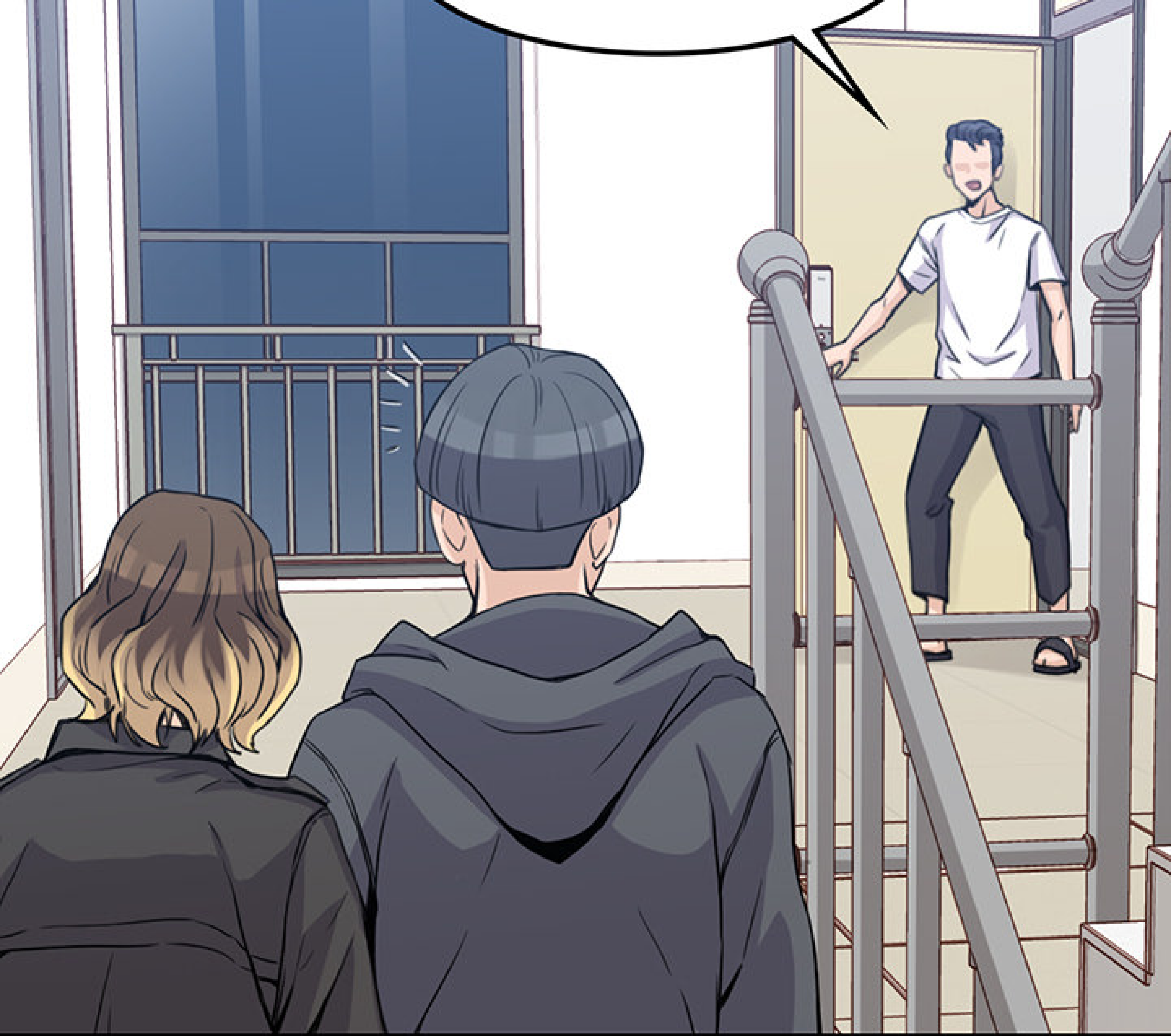



JE VEUX  
M'ALLONGER...



SOPHIE  
EST VRAIMENT  
SOÛLE...



OUAIS, ELLE L'EST...



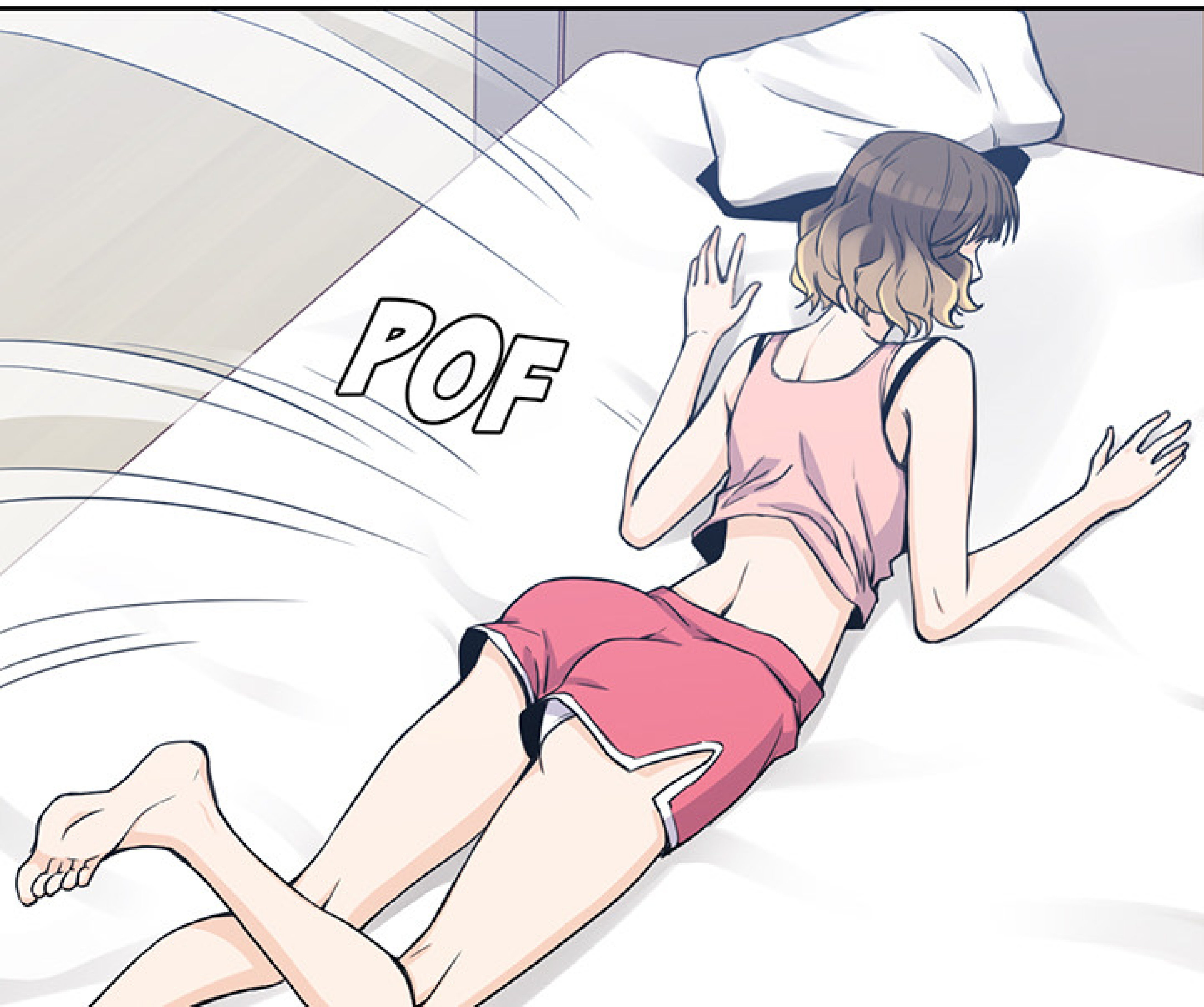

**POF**







SWIP

?

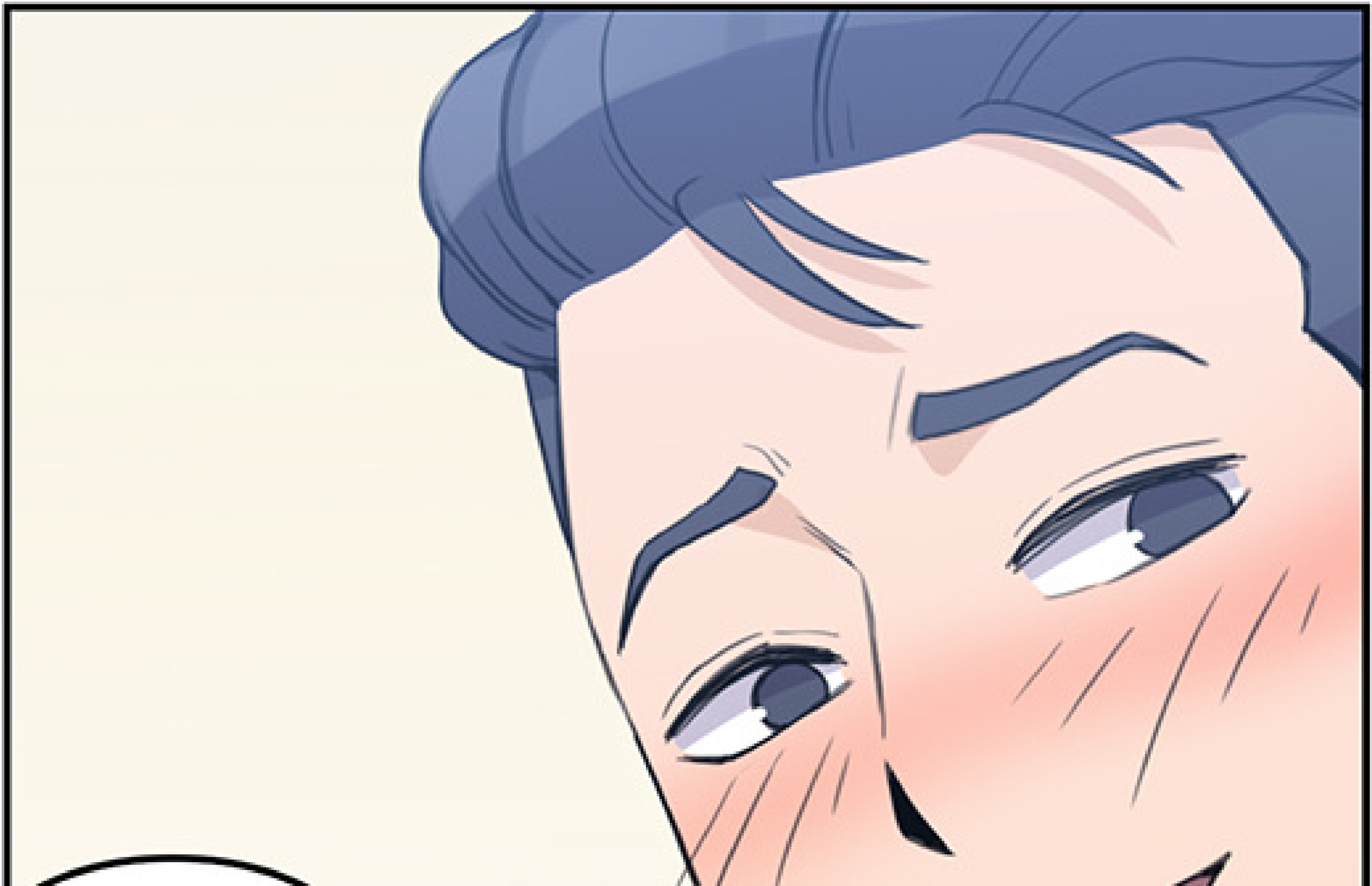





JIMMY...



TU DEVRAIS  
Y ALLER, IL EST  
TARD.



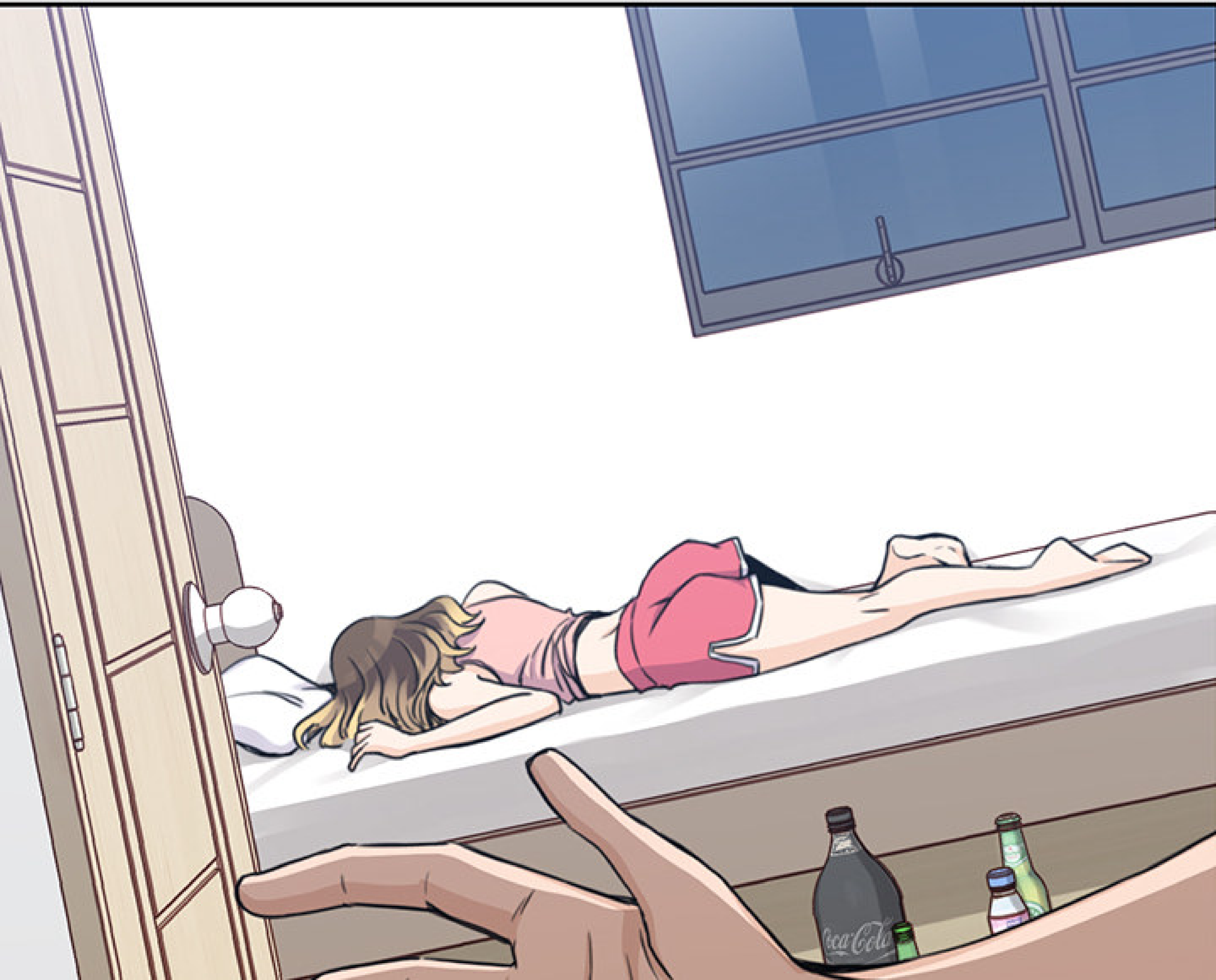



À SUIVRE...